

Des nichoir pour les rapaces nocturnes

Le nichoir à Chouette chevêche

type « caisse à vin »



Nichoir debout

Vue de face

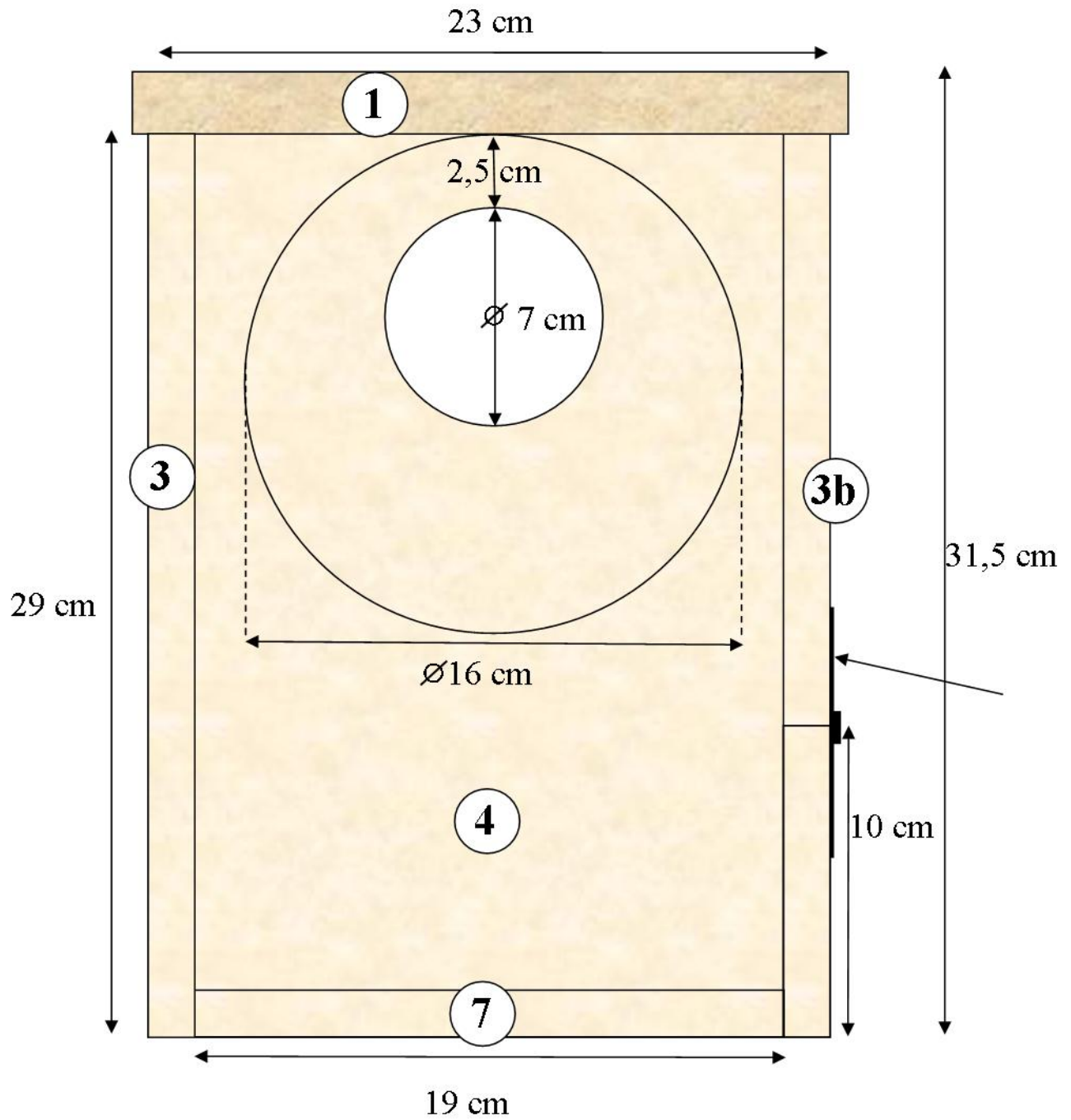

Nichoir ouvert
Vue de côté

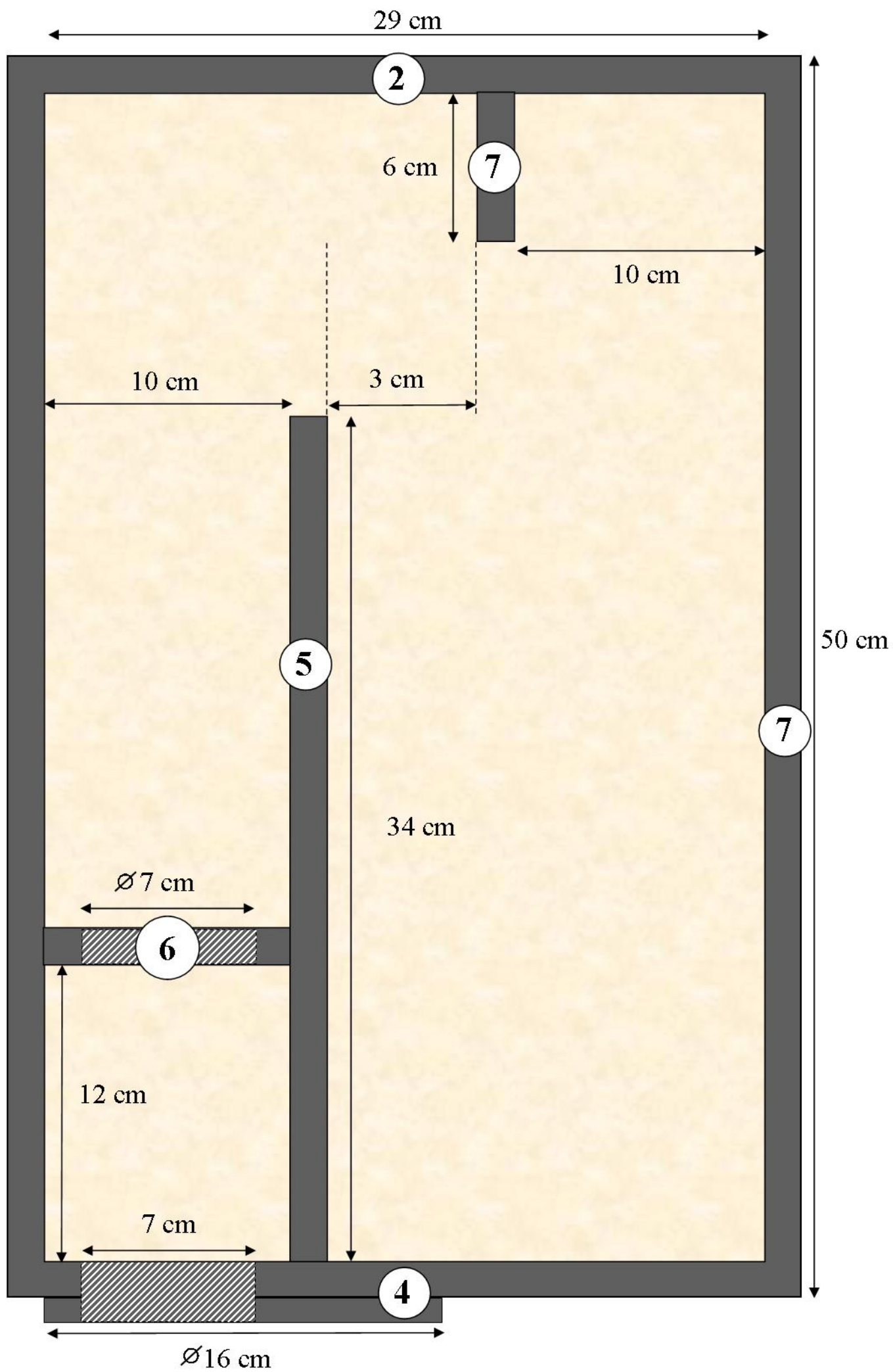

Les différents éléments

1

TOIT

X 2

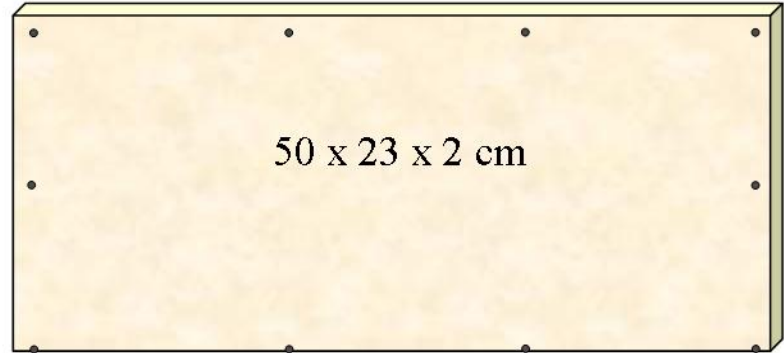

2

FOND

X 2

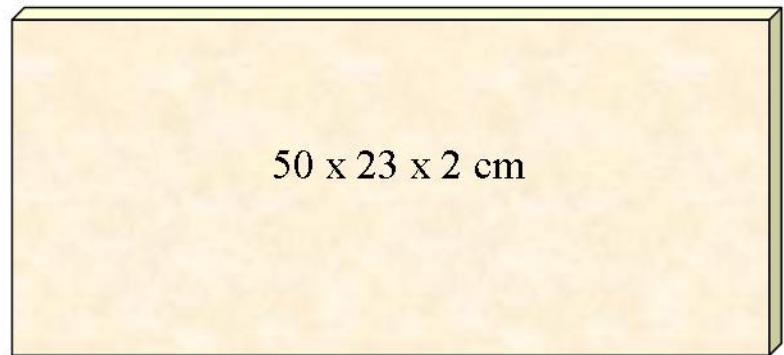

3

CÔTE GAUCHE

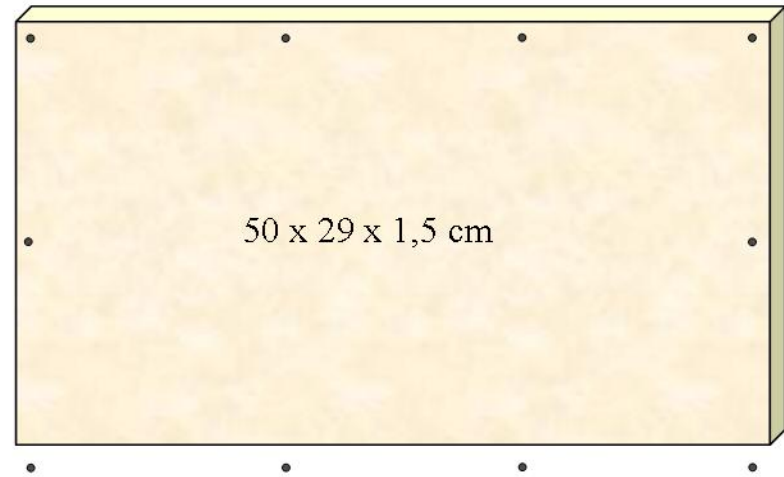

3 bis

CÔTE DROIT

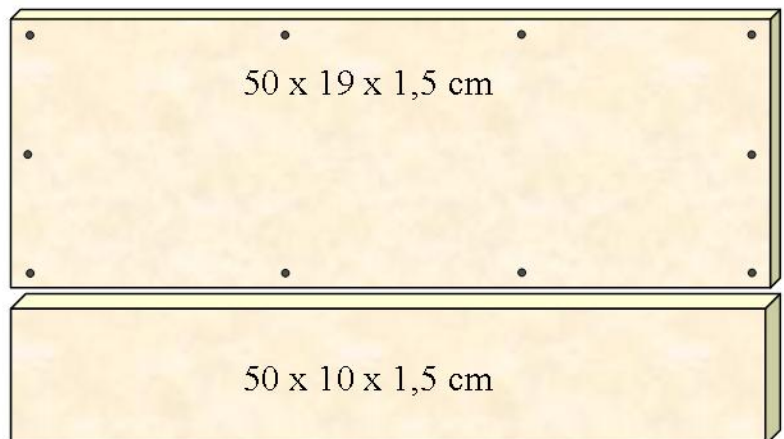

Les différents éléments

4

FACE ARRIERE

X 1



29 x 19 x 1,5 cm

4

FACE AVANT

X 1

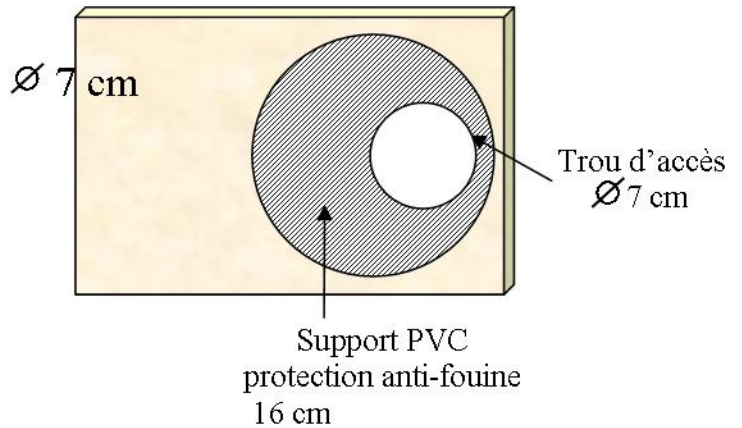

Tube PVC
Protection anti-prédateur
de 40 cm de long

Ø 16 cm

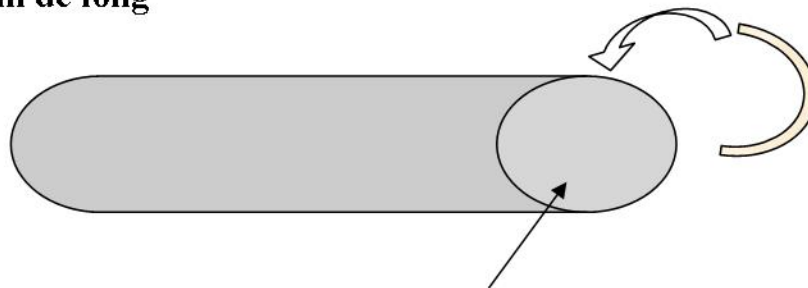

Demi-cercle en bois
(du diamètre du
tube) à visser
à l'entrée pour
maintenir la
litière à l'intérieur.

ATTENTION !

Ne pas oublier de mettre du terreau sur toute la longueur du tube pour éviter que l'oiseau ne glisse en progressant vers le fond.

Les différents éléments

5

PLANCHER
DE
L'ETAGE

34 x 19 x 1.5 cm

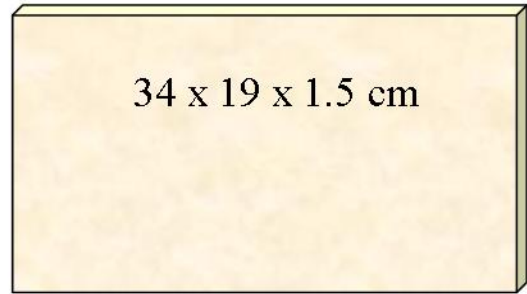

6

CLOISON
CHAMBRE

19 x 10 x 1.5 cm

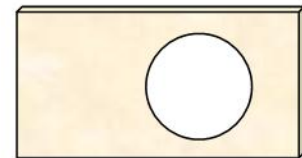

7

MARCHE

19 x 6 x 1.5 cm



8

CHARNIERE PIANO

X 2

8 x 2 cm

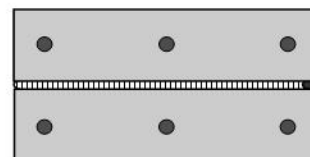

VIS

X 40

